

LOW-NOISE DUAL OPERATIONAL AMPLIFIER

■ GENERAL DESCRIPTION

The NJM5532 is a high performance dual low noise operational amplifier. Compared to the standard dual operational amplifiers, such as the NJM1458, it shows better noise performance, improved output drive capability, and considerably higher small-signal and power bandwidths.

This makes the device especially suitable for application in high quality and professional audio equipment, instrumentation, control circuits, and telephone channel amplifiers. The op amp is internally compensated for gains equal to one if very low noise is of prime importance, version be used which has guaranteed NJM5532DD it is recommended that the noise specifications.

■ PACKAGE OUTLINE

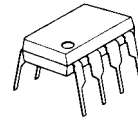

NJM5532D



NJM5532M

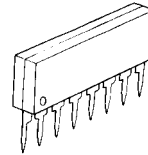

NJM5532L

■ FEATURES

- Operating Voltage ($\pm 3V \sim \pm 20V$)
- Small Signal Bandwidth (10MHz typ.)
- Output Drive Capability ($600\Omega, 10V_{rms}$ typ.)
- Input Noise Voltage ($5nV/\sqrt{Hz}$ typ.)
- Power Bandwidth (140kHz typ.)
- Slew Rate ($8V/\mu s$ typ.)
- Package Outline DIP8, DMP8, SIP8
- Bipolar Technology

■ PIN CONFIGURATION

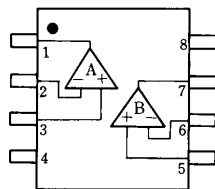

NJM5532D
NJM5532M

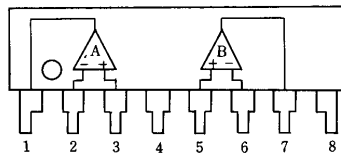

NJM5532L

PIN FUNCTION

- 1.A OUTPUT
- 2.A -INPUT
- 3.A +INPUT
- 4.V⁻
- 5.B -INPUT
- 6.B +INPUT
- 7.B OUTPUT
- 8.V⁺

■ EQUIVALENT CIRCUIT

(1/2 Shown)

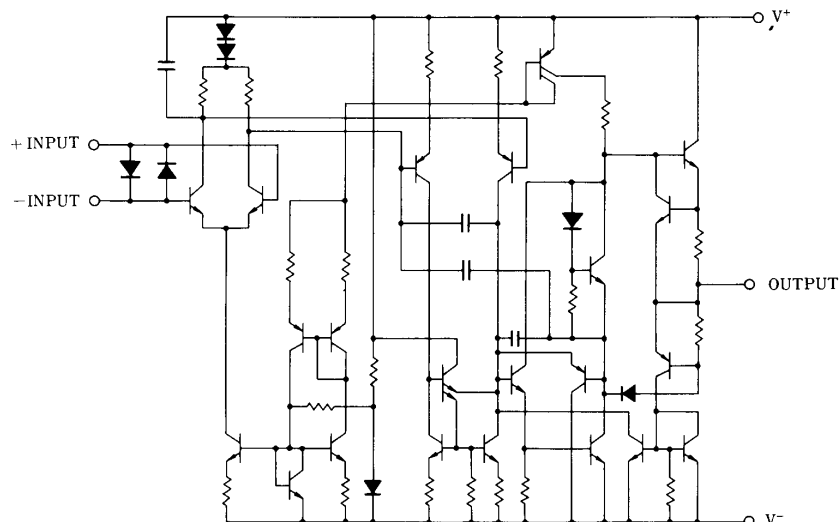

NJM5532

■ ABSOLUTE MAXIMUM RATINGS

(Ta=25°C)

PARAMETER	SYMBOL	RATINGS	UNIT
Supply Voltage	V^+ / V^-	± 22	V
Input Voltage	V_{IC}	V^+ / V^-	(V)
Differential Input Voltage	V_{ID}	± 0.5	V
Power Dissipation	P_D	(DIP8) 500 (DMP8) 600 (note) (SIP8) 800	mW
Operating Temperature Range	T_{opr}	-20~+75	°C
Storage Temperature Range	T_{stg}	-40~+125	°C

(note) At on a ceramic PCB (10x20x0.635mm)

■ ELECTRICAL CHARACTERISTICS

DC ELECTRICAL CHARACTERISTICS

($V^+ / V^- = \pm 15V, Ta = 25^\circ C$)

PARAMETER	SYMBOL	TEST CONDITION	5532			UNIT
			MIN.	TYP.	MAX.	
Input Offset Voltage	V_{IO}		-	0.5	4	mV
Input Offset Current	I_{IO}		-	10	150	nA
Input Bias Current	I_b		-	200	800	nA
Operating Current	I_{CC}		-	9	16	mA
Input Common Mode Voltage Range	V_{ICM}		± 12	± 13	-	V
Common Mode Rejection Ratio	CMR		70	100	-	dB
Supply Voltage Rejection Ratio	SVR		80	100	-	dB
Large Signal Voltage Gain 1	A_{V1}	$R_L \geq 2k\Omega, V_O = \pm 10V$	88	100	-	dB
Large Signal Voltage Gain 2	A_{V2}	$R_L \geq 600\Omega, V_O = \pm 10V$	83.5	94	-	dB
Maximum Output Voltage Swing 1	V_{OM1}	$R_L \geq 600\Omega$	± 12	± 13	-	V
Maximum Output Voltage Swing 2	V_{OM2}	$R_L \geq 600\Omega, V^+ / V^- = \pm 18V$	± 15	± 16	-	V
Input Resistance	R_{IN}		30	300	-	k Ω
Short Circuit Current	I_{OS}		-	38	-	mA

■ ELECTRICAL CHARACTERISTICS

AC ELECTRICAL CHARACTERISTICS

($V^+ / V^- = \pm 15V, Ta = 25^\circ C$)

PARAMETER	SYMBOL	TEST CONDITION	MIN.	TYP.	MAX.	UNIT
Output Resistance	R_O	$A_V = 30dB, f = 10kHz, R_L = 600\Omega, A_V = 1$	-	0.3	-	Ω
Overshoot		$V_{IN} = 100mV_{P-P}, C_L = 100pF, R_L = 600\Omega$	-	10	-	%
Gain	A_V	$f = 10kHz$	-	67	-	dB
Slew Rate	SR		-	8	-	V/ μs
Gain Bandwidth Product	GB	$C_L = 100pF, R_L = 600\Omega$	-	10	-	MHz
Power Bandwidth	W_{PG}	$V_O = \pm 10V$	-	140	-	kHz
Power Bandwidth	W_{PG}	$V_O = \pm 14V, R_L = 600\Omega, V^+ / V^- = \pm 18V$	-	100	-	kHz
Equivalent Input Noise Voltage 1	e_{n1}	$f_0 = 30Hz$	-	8	-	nV/ \sqrt{Hz}
Equivalent Input Noise Voltage 2	e_{n2}	$f_0 = 1kHz$	-	5	-	nV/ \sqrt{Hz}
Equivalent Input Noise Current 1	i_{n1}	$f_0 = 30Hz$	-	2.7	-	pA/ \sqrt{Hz}
Equivalent Input Noise Current 2	i_{n2}	$f_0 = 1kHz$	-	0.7	-	pA/ \sqrt{Hz}
Channel Separation	CS	$f = 1kHz, R_S = 5k\Omega$	-	110	-	dB

Note: JRC's general selected products D rank are also prepared for the noise standard ($R_S = 2.2k\Omega, R_{IAA}, V_N = 1.4\mu V$ Max.)

■ TYPICAL CHARACTERISTICS

Voltage Gain, Phase vs. Frequency
($T_a = 25^\circ\text{C}$)

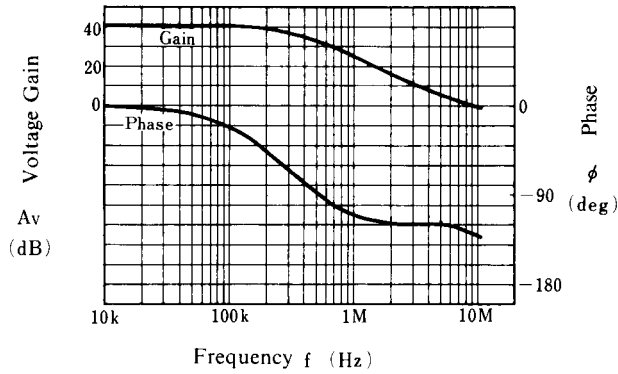

Maximum Output Voltage Swing vs. Load Resistance

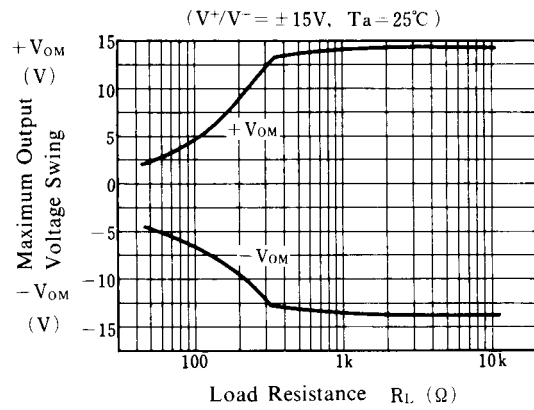

Maximum Output Voltage Swing vs. Frequency

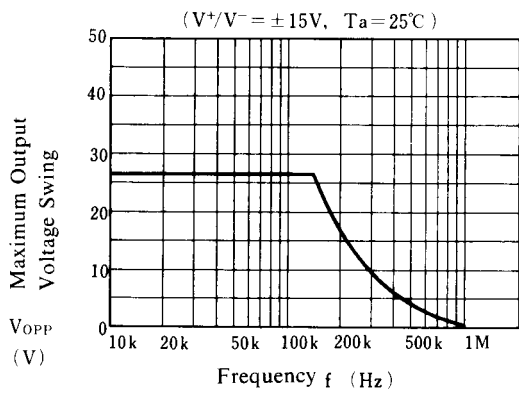

Equivalent Input Noise Voltage vs. Rs

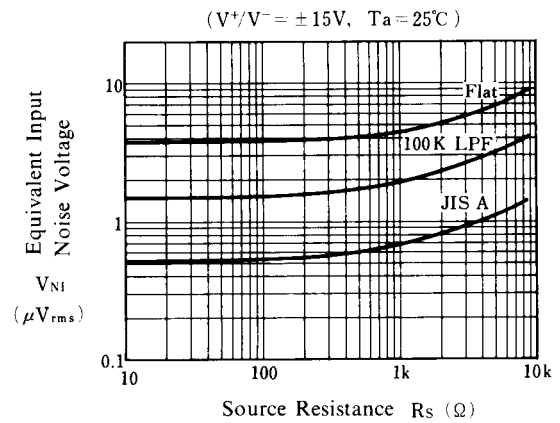

Equivalent Input Noise Voltage vs. Frequency

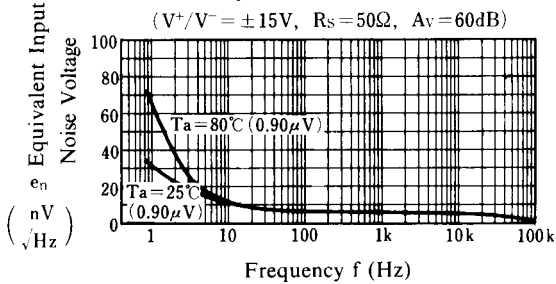

■ TYPICAL CHARACTERISTICS

Operating Current vs. Temperature

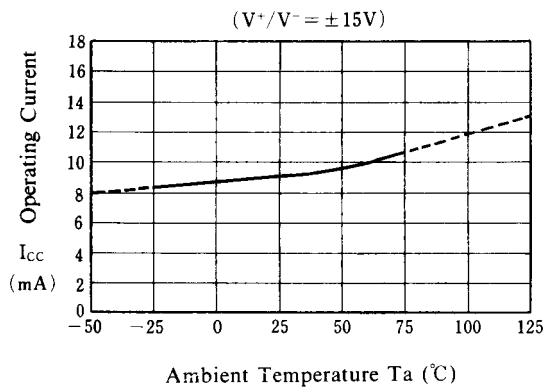

Maximum Output Voltage Swing vs. Temperature

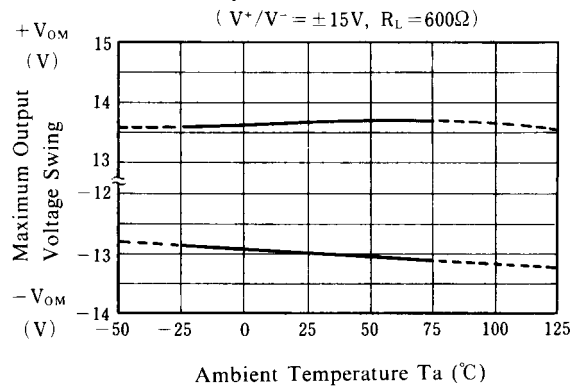

Input Offset Voltage vs. Temperature

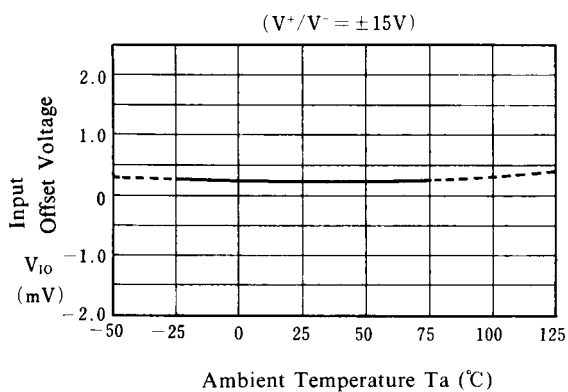

Input Bias Current vs. Temperature

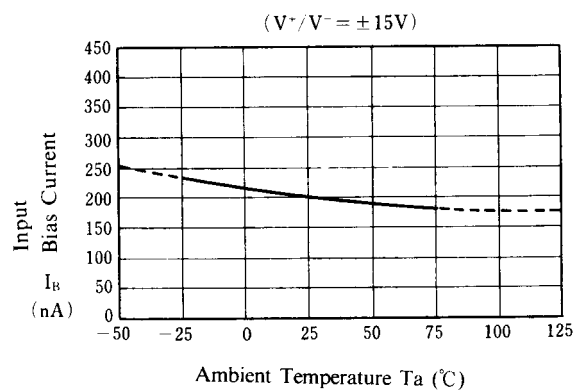

Operating Current vs. Operating Voltage

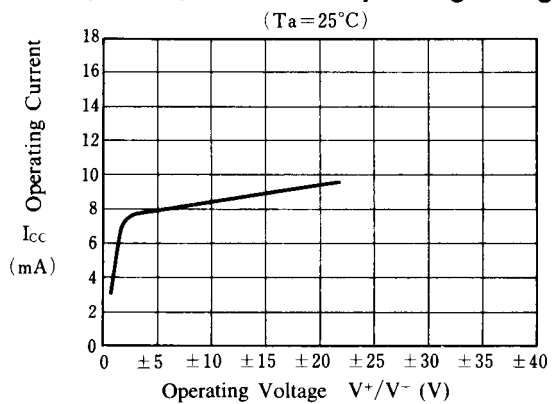

Maximum Output Voltage Swing vs. Operating Voltage

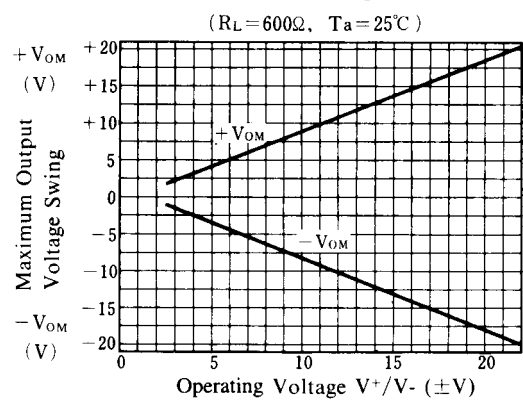

■ TYPICAL CHARACTERISTICS

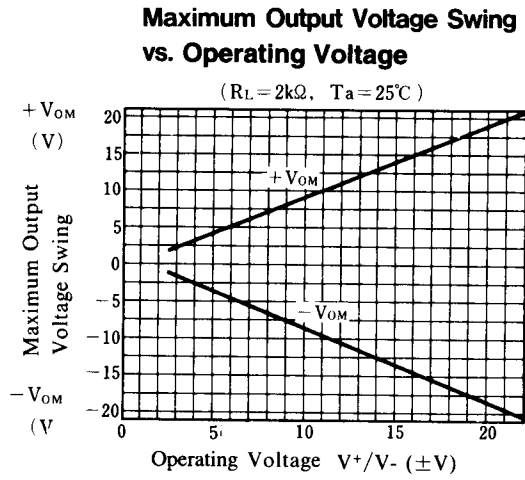

Total Harmonic Distortion vs. Output Voltage
($V^+/V^- = \pm 15V$, $R_L = 10k\Omega$, Gain = 20dB, $T_a = 25^\circ C$)

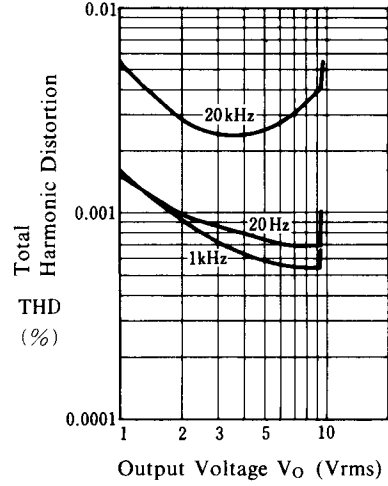

■ NOTICE

When used in voltage follower circuit, put a current limit resistor into non-inverting input terminal in order to avoid inside input diode destruction when the power supply is turned on. (ref.Fig.1)

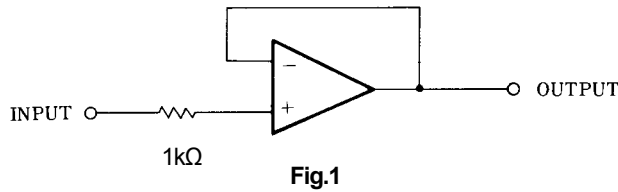

[CAUTION]
The specifications on this databook are only given for information, without any guarantee as regards either mistakes or omissions. The application circuits in this databook are described only to show representative usages of the product and not intended for the guarantee or permission of any right including the industrial rights.